

# KIT ROLETE

Fechadura Residencial Trinco Rolete

Porta Pivotante

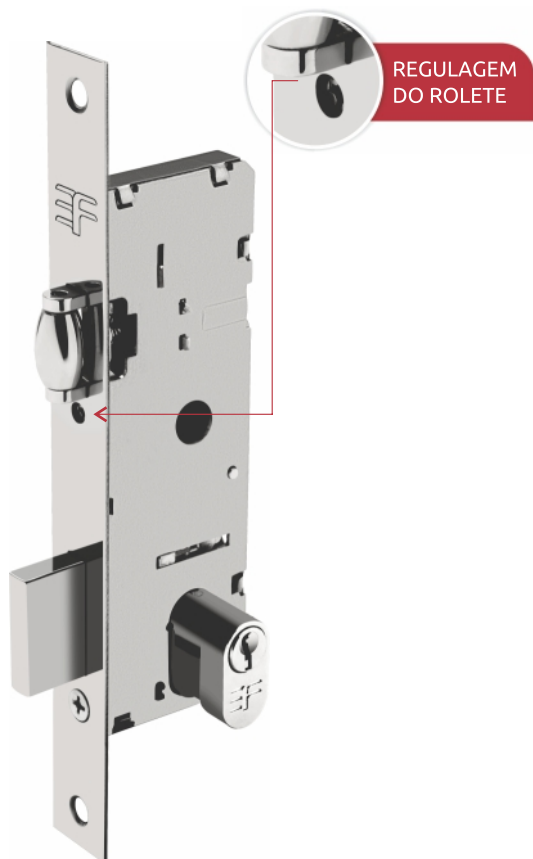

529R51KIT



4129

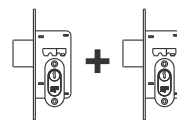

! O kit pode acompanhar até 2 fechaduras auxiliares

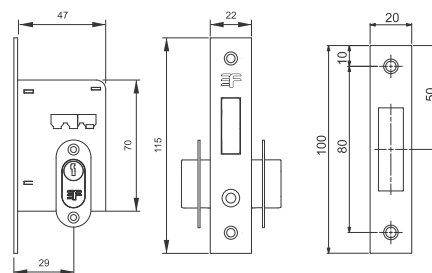
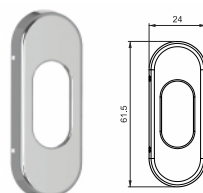
**CONTRA TESTA**

**ESPELHOS OBLONGOS**
**ESPELHO DESIGN**

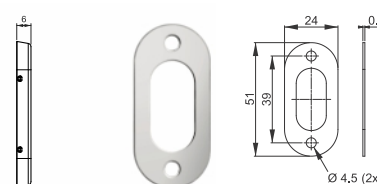
529R51KIT3CR-ED

**ESPELHO PLANO**

529R51KIT3CR

! **ATENDE TUBO/METALON DE FERRO OU PERFIL DE ALUMÍNIO 50 X 30**

Também atende perfis búzios com os cilindros 3F de 74mm ou 90mm

! **CONTRA TESTA**  
A fechadura acompanha 02 contra testas: ESQUERDA e DIREITA

! Abertura de todas as fechaduras do kit com **UMA ÚNICA CHAVE!**

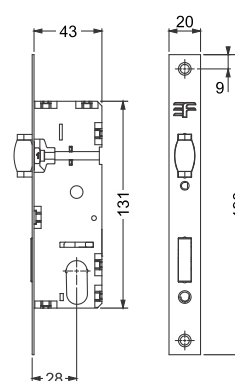
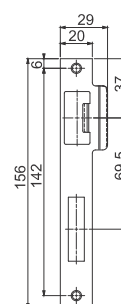
**CONTRA TESTA**

**ESPELHO OBLONGO**  
Broca 28 - Cilindro Monobloco 50/74/90mm

EXTERNA Atende a norma ABNT/NBR 14913



Cromo Acetinado

Cromado/INOX



Pintado Branco

Pintado Preto

**MAIOR RESISTÊNCIA / MAIOR DURABILIDADE**

- . Rolete e Cilindro CROMADOS
- . Contra testa e Chapa-testa de AÇO INOX
- . Chave, Rolete, Pino e Contra-pino de LATÃO
- . Espelho Oblongo de AÇO INOX

**ESPESSURA MÁXIMA DA PORTA**

CILINDRO	ESPELHO OBLONGO PLANO	ESPELHO OBLONGO DESIGN
50mm	40mm	30mm
74mm	65mm	55mm
90mm	80mm	70mm

REFERÊNCIA	ESPESSURA DA MÁQUINA (A)
529R	14,5mm
4129	16mm